

① Fitted depending on features

Designation	LCS	Document No.	Rev	Sheet-No.
Connection Diagram	EN	5600 0001074481	C	1
GV640 / 440 ll. Gen		Material No. 9000505353		of 1

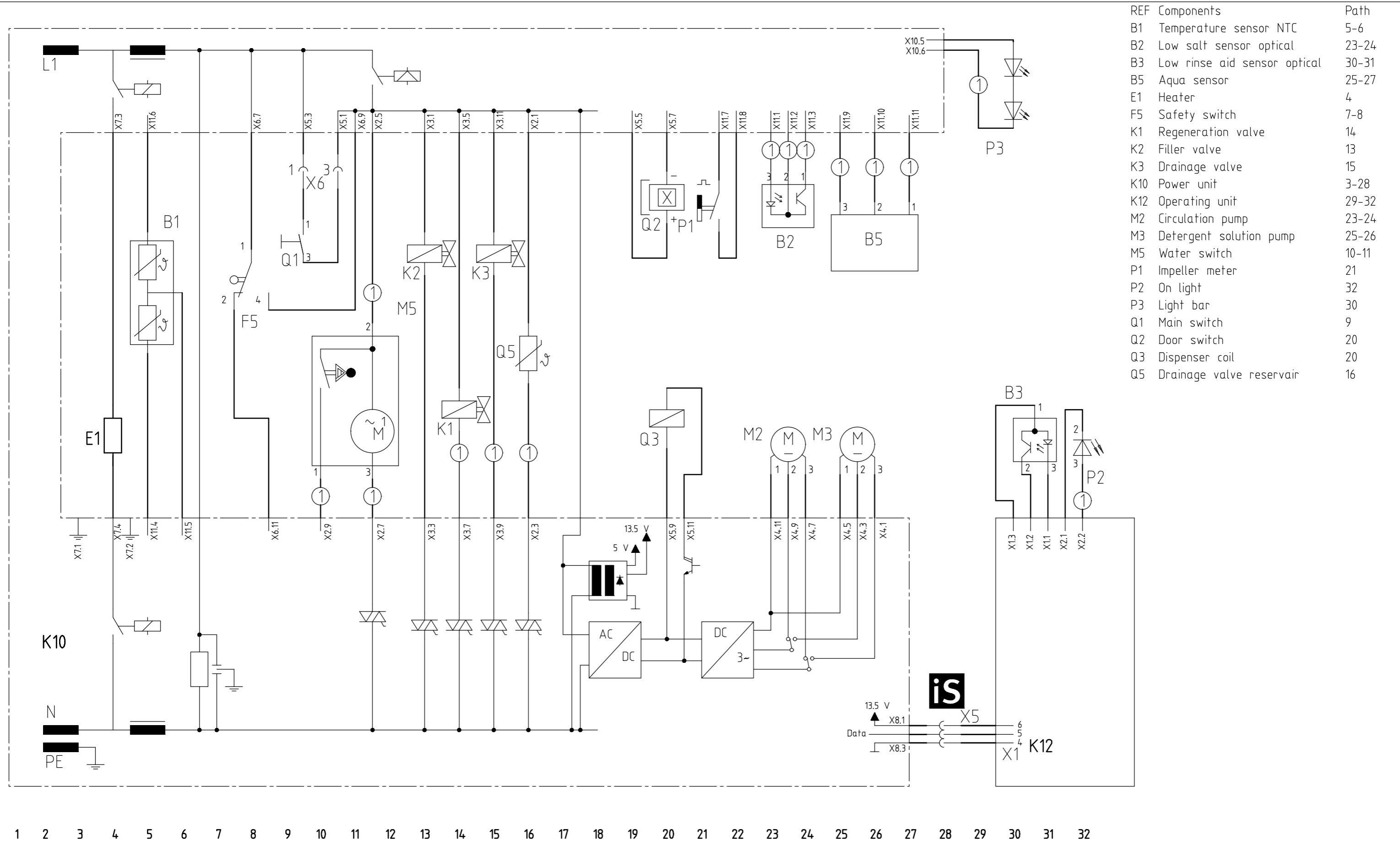









REF	Components	Path
B1	Temperature sensor NTC	5-6
B2	Low salt sensor optical	23-24
B3	Low rinse aid sensor optical	30-31
B5	Aqua sensor	25-27
E1	Heater	4
F5	Safety switch	7-8
K1	Regeneration valve	14
K2	Filler valve	13
K3	Drainage valve	15
K10	Power unit	3-28
K12	Operating unit	29-32
M2	Circulation pump	23-24
M3	Detergent solution pump	25-26
M5	Water switch	10-11
P1	Impeller meter	21
P2	On light	32
P3	Light bar	30
Q1	Main switch	9
Q2	Door switch	20
Q3	Dispenser coil	20
Q5	Drainage valve reservoir	16

① Fitted depending on features

Designation <b>Circuit Diagram</b> GV 640 / 440 II Generation	LCS <b>EN</b>	Document No. <b>5600 0001073685</b>	Rev <b>C</b>	Sheet-No. 1 of 1
		Material No. 9000505352		















# Fault Codes and Service Programmes

Display CS Program		Display Customer		Description	Appliance behaviour	Results of internal check	Measures
Display	LED	Display	LED	 LED off  LED on  flashes fast  flashes slow	*) only for appliances with Zeolite drying system		
	Act. End	Clean End	Sani				
E:00	  			No error	---		---
h:00 – h:24				No error	Appliance does not start	Delay timer is activated!	No appliance fault!
All LED's are on				Interface error	Appliance without function	Appliance must be disconnected from the power supply after flash process (main switch on/off is not adequate!)	
  <b>LED's flashing</b>					Stops in current position, Appliance without function	Communication error between the electronics  (For appliances with piezo control modules the cause can also be water in the bottom tray)	<ul style="list-style-type: none"> <li>- <b>Disconnect appliance from the power supply (unplug and plug in again)</b></li> <li>- Check D-bus plug-and-socket connections (3-pole wire) for electrical connection faults</li> <li>- Run Flash process again</li> <li>- Replace module</li> </ul>

# Fault Codes and Service Programmes

Display CS Program		Display Customer		Description	Appliance behaviour	Results of internal check	Measures	
Display	LED	Display		LED off LED on flashes fast flashes slow	*) only for appliances with Zeolite drying system			
	Act. Clean End Sani							
E:01		E:01		Internal fault power module	→ End of program	EI. Connection to pumps interrupted	Check wire / connectors (At pumps and power module)	
						Voltage drops because of bad main connecting	Check connection of the main connecting at appliance back side and socket-outlet	
						Power module defect (internal pump control)	Start Test program <b>Just if E:01 occur again, power module has to replaced!</b>	
E:02		E:02		Internal fault power module	Operates without heating	Heater relay defective	Replace the power module	
E:03		E:03			Operates without auxiliary drying system *)	Relay for auxiliary heater defective		
E:04		E:04				Operates without heater	- Ground fault at zeolite heater - Safety relay heater defective	- Replace zeolite heater - Replace the power module
		New appliances, until FD 9108 may have stored error code E:04 once during the first 8 wash cycles.				No appliance fault!		
E:05		E:05				Water switch is running continuously → program termination with draining	Triac for water switch motor defective	Replace the power module
E:06		E:06	Door Hall sensor fault	Stops in current position, appliance without function		Wire to the Hall sensor interrupted or power module defective	Check wire / plugs Measure voltage on the Hall sensor	
				Hall sensor defective	→ If voltage on the Hall sensor is o.k., replace Hall sensor			

# Fault Codes and Service Programmes



















Display CS Program		Display Customer		Description	Appliance behaviour	Results of internal check	Measures
Display	<b>LED</b>	<b>Display</b>		 LED off  LED on flashes fast flashes slow	*) only for appliances with Zeolite drying system		
	 Act.  Clean  End  Sani						
<b>E:07</b>		<b>E:07</b>		Heating fault	Operates without auxiliary drying system *)	Fan defective or blocked, fan module defective	Check components and connection wires, measure winding.
<b>E:08</b>					Operates without heater	Heat pump detects too low water level in the sump.	Heat exchanger valve leaking Bowls / pans overturned in the appliance?
<b>E:09</b>		<b>E:09</b>			Operates without heater	Low mains voltage (until FD 9108)	No appliance fault!
<b>E:10</b>		<b>E:10</b>			Operates without auxiliary drying system *)	Zeolite heater heating circuit interrupted (resistance / supply wires)	Measure heater resistance Check wires
					Operates without auxiliary drying system *)	Fan module defective	Check component
					Operates without auxiliary drying system *)	Wires interrupted/broken	Check wires
<b>E:11</b>		<b>E:11</b>			Operates without heater	NTC resistance values outside permitted range	Measure NTCs
					Operates without heater	Wire or plug interrupted	Check wires / plugs
<b>E:12</b>		<b>E:12</b>			Operates without auxiliary drying system *)	NTC resistance values outside permitted range (not available at all appliances)	Measure NTCs
<b>E:13</b>					Operates without heater	Water temperature too high (>75 °C)	Protective measure – no appliance fault! Check temperature of water supply

	Document-No.: 5600 0000178398 ASP EN	Revision C	Page No.
Fault Codes PM II - 2	Material-No.: 9000.765.783		3 of 6









# Fault Codes and Service Programmes

Display CS Program		Display Customer		Description	Appliance behaviour	Results of internal check	Measures	
Display	<b>LED</b>	<b>Display</b>		LED off LED on flashes fast flashes slow	*) only for appliances with Zeolite drying system			
	Act. Clean End Sani							
E:14		E:14	●	●	Filling fault	Program stops with draining	No impulses from flow sensor, although water is detected by heat pump	Check wires, test flow sensor (reed switch)
E:15		E:15				Program stops with intermittent pumping	Safety switch in base activated. Appliance cannot be switched off	- Identify reasons for water in the base and rectify - if there is no water in base, check wires / plugs (eg. bent plug contact)
E:16		E:16				Water supply (impulses from flow sensor) without activation of the fill valve	Check filli valve Check actuation of fill valve	
E:17		E:17				Program stops with draining	Water supply rate too high according to flow sensor	Check flow controller in the fill valve
E:18		E:18	●	●		Wait for supply; program stops with draining	Water supply rate too low according to flow sensor or no water supply	Check water supply
E:19						Reserved	---	
E:20		E:20			Circulation pump fault	→ End of program	Resistance values of Circulating pump wrong	Check wires / plugs Measure resistance values of windings
E:21		E:21				→ End of program	Circulating pump blocked	Check Circulating pump for foreign objects, if required replace

# Fault Codes and Service Programmes

Display CS Program		Display Customer		Description	Appliance behaviour	Results of internal check	Measures	
Display	<b>LED</b>	<b>Display</b>		 LED off  LED on flashes fast flashes slow	*) only for appliances with Zeolite drying system			
	 Act.  Clean  End  Sani							
<b>E:22</b>	 	<b>E:22</b>	●	●	Drain pump fault	→ End of program	Residual water in the sump, because of dirty filters	Clean filters
<b>E:23</b>		<b>E:23</b>				→ End of program	Resistance values of drain pump wrong	Check wires / plugs Measure resistance values of windings
<b>E:24</b>		<b>E:24</b>	●	●		→ End of program	Non-return valve letting by	Check non-return valve, ensure correct closing
							Draining not possible	Check water drainage (hose kinked, blocked, delivery height, pump cover)
							Drain pump cover in sump is missing / loose	Attach drain pump cover
<b>E:25</b>	<b>E:25</b>	●	●	→ End of program	Drain pump blocked	Check drain pump for foreign objects		
					Drain pump cover in sump is missing / loose	Attach drain pump cover		
<b>E:26</b>	   				Water switch fault	Permanet activation of water switch	No impulses from water switch despite actuation	Check wires Measure mains voltage on the motor Test switch at water switch
<b>E:27</b>	   	<b>E:27</b>		●	Undervoltage fault	→ End of program	Continuous low mains voltage (<170 V)	No appliance fault!
<b>E:28</b>					AquaSensor fault	Operates without AquaSensor	Appliance without AquaSensor	Is appliance equipped with AquaSensor?
							Calibration of AquaSensor not successful	Check wires AquaSensor dirty?

# Fault Codes and Service Programmes

Display CS Program		Display Customer		Description	Appliance behaviour	Results of internal check	Measures
Display	<b>LED</b>	<b>Display</b>		 LED off  LED on flashes fast flashes slow	*) only for appliances with Zeolite drying system		
	 Act.  Clean End  Sani						
<b>E:29</b>				Under / over voltage error	Stops in current position, appliance without function, Malfunctions, unsatisfactory rinsing / drying result Cycle duration increase	Low mains voltage (<170V / 190V)	No appliance fault!
<b>E:30</b>					Appliance switches off	Overvoltage (>290 V)	No appliance fault!
<b>E:31</b>		<b>E:31</b>		Water sensor in zeolite heater shows fault	Operates without heater *)	Water in the zeolite container	Exchange the zeolite heater and zeolite container - too much foam in the appliance? - appliance overfilled? (Inlet valve / Aqua stop letting by, appliance tilted backwards, ..)
						Water sensor dirty	Exchange the zeolite heater
<b>E:32</b>				Internal error code		Reserved	Not relevant to customer service



# Customer Service Program

Function	Display	Remark				
	Display	Can be skipped	Time (s)	Value	Check / Measure	Remark

## 1.1 Customer Service Program

<b>Preparation</b>					Remove approx. 0.5 l water from salt dispenser.	Regeneration valve must be checked for leaks at appropriate customer specifications (see also steps with display S:04 + S:28)
<b>CoilCheck</b>	S:00	No	approx. 20			Check the drain pump. Activate the drain pump and place the water switch in the top basket position.
<b>Check flow sensor and flow controller</b>	S:01	No	approx. 10-100			Add 50 ml (filling valve, drainage pump and circulation pump are activated in succession).
<b>Pause</b>	S:02	No	10			
<b>Storage tank valve „on“ =&gt; Fill + pump</b>	S:03	No	approx.200			Heat exchanger is overfilled, residual quantity in the pump sump is pumped off ==> heat exchanger full.(contains 3.1 l water) Storage tank evacuate
<b>Pause</b>	S:04	No	10		Visual inspection: water level in salt dispenser.	No change to water level ==> Regeneration valve leakproof.
<b>Fill</b>	S:05	No	approx. 40	1,5 l	Check waterinlet amount	Within of 40s should the filling amount achieved. The heat exchanger will be overfilled
<b>Pause</b>	S:06	No	10		Visual inspection: water level in appliance.	Water level on upper edge of fine mesh filter (= 1.5 l in pump sump).
<b>Fill</b>	S:07	No	approx. 60	2,5 l		Total: 4 l in appliance
<b>Circulate</b>	S:08	No	15			Circulation pump must not “snorkel”.
<b>Pause</b>	S:09	No	10			

	Document-No.: <b>56000000171142</b> ASP EN	Revision A	Seite-Nr.
Customer Service Program	Material-No.: 9000.541.215		1 of 4

# Customer Service Program

Function	Display	Remark				
	Display	Can be skipped	Time (s)	Value	Check / Measure	Remark
Storage tank valve „on“ + Water switch position roof sprinkler + Circulate	S:10	No	approx. 70			Storage tank valve open,, Waterswith to position, Fil storage tank
Storage tank valve open + Circulate + heat	S:11	Yes		70°		Flush storage tank Increase of temperature during heating +2.5 °C/min.
Close storage tank + Circulate	S:12	No	approx.180			Storage tank full (2,0 l)
Pause	S:13	No	10			
Fill	S:14	No	approx. 30	2,0 l		Total: 4 l in appliance
Dispense (detergent)	S:15	No	10			
Circulate + heat + calibrate AquaSensor	S:16	No	110			
Circulate + heat	S:17	Yes		40 °C		Increase of temperature during heating +2.5 °C/min
Pause	S:18	No	5			
Circulate + dispense (rinse aid)	S:19	No	60			Number of impulses = set value of dispensed rinse aid
Circulate + heat + change position of water switch	S:20	Yes	approx. 480	65 °C		Increase of temperature during heating +2.5 °C/min. Change every 30 s roof shower head, top basket, bottom basket.
Pump off	S:21	No	45			Tightness test of outlet valve Water-level at heat exchanger is not supposed to falling off
Drain heat exchanger	S:22	No	60			Check outlet valve

	Document-No.: <b>56000000171142</b> ASP EN	Revision A	Seite-Nr.
Customer Service Program	Material-No.: 9000.541.215		2 of 4
The reproduction, transmission or use of this document or its contents is not permitted without express written authority. Offenders will be liable for damages. All rights including rights created by patent grant or registration of a utility model or design are reserved. Copyright reserved.			

# Customer Service Program

Function	Display	Remark				
	Display	Can be skipped	Time (s)	Value	Check / Measure	Remark
Pause	S:23	No	10		Visual inspection: water level in appliance.	Water level must be over handle of coarse filter
Partial pump	S:24	No		approx. 2,0l		
Storage tank valve „on“	S:25	No	approx.180			Storage tank is going evacuated
Pause	S:26	No	10			
Pump off + drain heat exchanger + fill + regenerate	S:27	No	approx. 20			Drain the complete appliance
Pause	S:28	No	10		Visual inspection: water level in salt dispenser.	Water level in salt dispenser must be increased by several cm.
Pump off + drain heat exchanger + fill	S:29	No	approx. 100	4 l		Rinse the brine solution out of the heat exchanger and pump sump.
Pum off + drain heat exchanger	S:30	No	30			Drain the complete appliance
Check whether appliance was drained (activates circulation pump and drain pump)	S:31	No	approx. 10-120			Self-check whether appliance was drained
End of test programme	“0” on display or “End LED” is lit				Switch off main switch	Test has ended. When the appliance is next switched on, the normal rinse programme is displayed

	Document-No.: <b>56000000171142</b> ASP EN	Revision A	Seite-Nr.
Customer Service Program	Material-No.: 9000.541.215		3 of 4
The reproduction, transmission or use of this document or its contents is not permitted without express written authority. Offenders will be liable for damages. All rights including rights created by patent grant or registration of a utility model or design are reserved. Copyright reserved.			

# Customer Service Program

Function	Display	Remark				
	Display	Can be skipped	Time (s)	Value	Check / Measure	Remark

## 1.2 Reset program

Reset					Perform reset	Is possible at any time by pressing the button "Start" for longer than 3 seconds

# Service-Programme

Function	Actuation	Display L1 L2 L3	Remark
----------	-----------	---------------------	--------

## 1.1 Operating diagram

			<ul style="list-style-type: none"> <li>○ LED off</li> <li>● LED on</li> <li>☀ LED flashes</li> </ul>
--	--	--	--

## 1.2 Special programmes

Precondition			Switch on the appliance: - Appliance is in rinsing program -> in this case carry out "Reset", switch off the appliance and switch it on again. - Appliance is in program selection -> in this case see next step (selection)
			Switch off the appliance
Selection			Press and hold down buttons "A" + "B"
			Press the main switch
			Release buttons when LED L2 flashes and LED L3 is on

Request Service-Programme	Document-No.: 5600 0000157762 ASP EN	Revision D	Seite-Nr.
	Material-No.: 9000.371.964		1 of 3
The reproduction, transmission or use of this document or its contents is not permitted without express written authority. Offenders will be liable for damages. All rights including rights created by patent grant or registration of a utility model or design are reserved. Copyright reserved.			

# Service-Programme

Function	Actuation	Display L1 L2 L3	Remark
Select			Press button "A" until required programme is selected
			Error memory Customer service test programme Not relevant to customer service Not relevant to customer service Not relevant to customer service Not relevant to customer service Not relevant to customer service Demonstration programme

## 1.3 Read out error memory

			Activate: Press button "B"
		Various	Fault code is displayed via rapidly flashing LEDs L4, L5, L6 Highest order fault from last rinse cycle is displayed

## 1.4 Customer service test programme

			Activate: Press button "B" and close the door
			Test programme is active
Skip test step			Open the door and press button "A" Not all test steps can be skipped (see customer service test programme)

	Document-No.: 5600 0000157762 ASP EN	Revision D	Seite-Nr.
Request Service-Programme	Material-No.: 9000.371.964		2 of 3
The reproduction, transmission or use of this document or its contents is not permitted without express written authority. Offenders will be liable for damages. All rights including rights created by patent grant or registration of a utility model or design are reserved. Copyright reserved.			

# Service-Programme

Function	Actuation	Display L1 L2 L3	Remark
----------	-----------	---------------------	--------

## 1.5 Special programme stopped

In error memory			Switch off main switch
In customer service test programme			Press "Start" button for 3 seconds (Reset)
			Switch off main switch

## 1.6 Demonstration programme

Select		● ● ●	Activate: Press button "B"
		LED „ECO“ is on	If there is no LED "ECO", LED L1 is on
End	Door		When programme is running, open door
		LED „ECO“ off LED „End“ is on	Press "Start" button for 3 seconds (Reset)
		LED „End“ off	Hold down buttons "A" + "B"
			Switch off main switch

	Document-No.: 5600 0000157762 ASP EN	Revision D	Seite-Nr.
Request Service-Programme	Material-No.: 9000.371.964		3 of 3